

HYDRON INCORPORATED

TACKLE BLOCKS



- Hastings Insulated Blocks are designed for all types of hoisting related jobs. They are especially ideal for hot line use.
- Bodies are made from high impact, dielectric material.
- All hooks have full swivel capabilities.
- Sheaves are made with fiberglass reinforced nylon material.
- Shafts are stainless steel - swivel hooks are plated and include hot eye for application with hot sticks.

No.	Description	Upper	Lower	Weight
11361	Blocks only - no rope	2 Sheave	2 Sheave	6 1/2 lbs
11362	Blocks with 120' 1/2" Polydacron rope	2 Sheave	2 Sheave	16 lbs
11367	Blocks only - no rope	3 Sheave	3 Sheave	6 3/4 lbs
11368	Blocks with 150' 1/2" Polydacron rope	3 Sheave	2 Sheave	20 lbs
11051	Single Block only	2 Sheave	2 Sheave	3 1/4 lbs
11052	Single Block only	3 Sheave	----	3 1/2 lbs

NOTE: Maximum loading of blocks should not exceed 2,000 lbs.

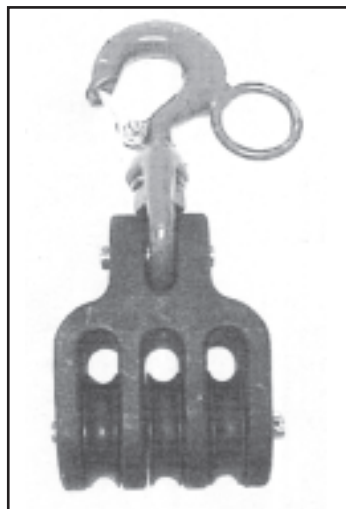

11051 Block



11052 Block

LINE
CONSTRUCTION
TOOLS

320 Libbey Industrial Parkway, Weymouth, Massachusetts 02189
Phone 781-331-5500 • Fax 781-331-5508 • www.hydroninc.com

HYDRON INCORPORATED

STRINGING BLOCK



6707

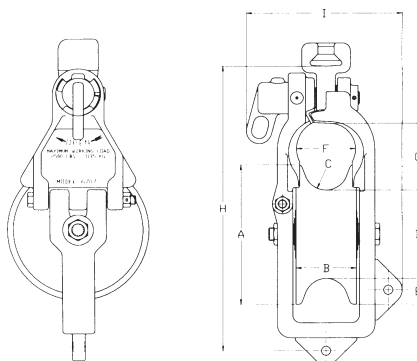

Block Dimensions		
A	Sheave Dia.	7"
B	Sheave Width	3"
C	Groove Radius	1 1/6"
D	Sheave Root Dia.	4 3/8"
E	Groove Depth	1 5/16"
F	Throat Width	2 1/8"
G	Throat Height	3 1/8"
H	Block Height	14 1/8"
I	Block Width	7 5/8"

ACCESSORIES

LINE
CONSTRUCTION
TOOLS

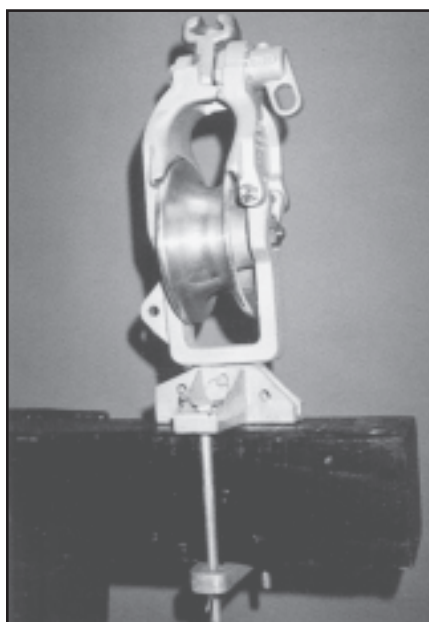

Adjustable Cross Arm Base

Clamps to any wood cross arm up to 6" x 6". A quick release pin holds the block in a wide range of positions and angles.

- Working Load - 2500 lbs. mounted vertically or suspended.
- All edges are smoothly contoured to prevent damage to rope or conductor.
- Frame is compatible with existing blocks and attachment hardware.
- Gate latch is designed for safe, smooth, single motion hotstick operation allowing the conductor to be removed from the same side.
- Gate Opening Latch is a one hand operation.
- Enclosed Top to protect rope or conductor in case of uplift.
- Extended Rope Guards prevent rope from snagging between frame and sheave.

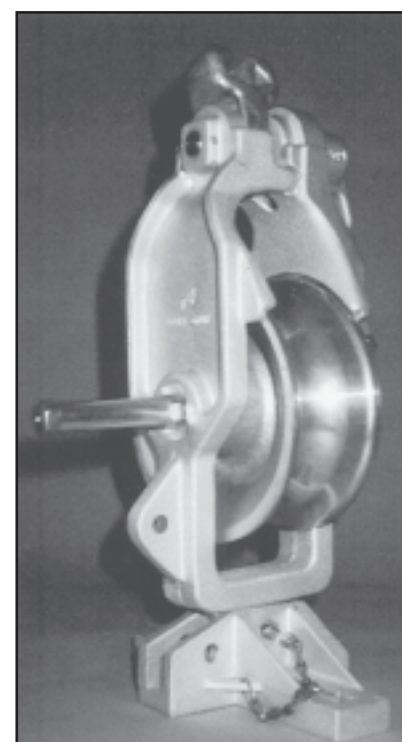

Grounding Block

Model 6707-GB provides an extended shaft for ground clamp connection.

320 Libbey Industrial Parkway, Weymouth, Massachusetts 02189
Phone 781-331-5500 • Fax 781-331-5508 • www.hydroninc.com

HYDRON INCORPORATED

STRINGING BLOCK

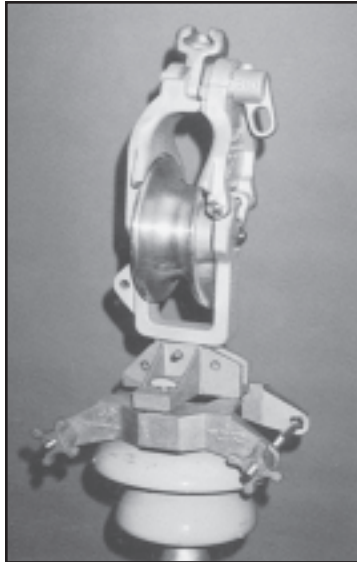

TIA - Base for Tie Top Insulator

This adjustable base clamps to the neck of a tie top insulator. Rubber cushions protect the porcelain. The block can be mounted in a wide range of positions and angles.

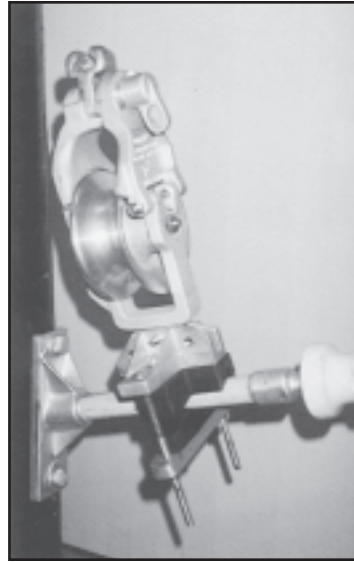

FIA - Base Insert for Fiberglass Insulator Bracket

With the addition of these molded rubber inserts, the cross arm base (not included) will clamp to a fiberglass insulator bracket.

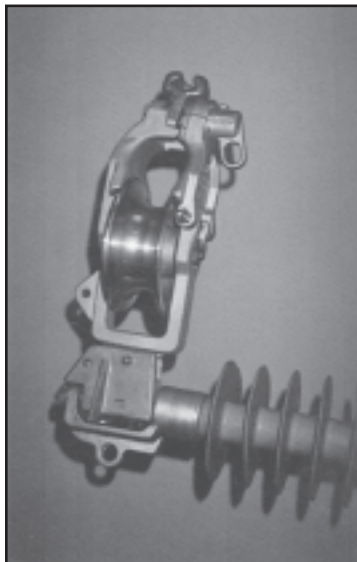

LPA - Base for Line Post Insulator

This base is used with horizontal or vertical line post insulators. The base fits in the metal insulator cap and is held by the bolt used to secure the constructor clamp. The base permits a block angle of 30° for stringing through line angles.



PD-2 - Pole Mount Bracket

The pole mount bracket attaches to a wood pole by a web binder strap. The ball clevis on the bracket fits all blocks equipped with a socket connector.

LINE
CONSTRUCTION
TOOLS

Optional Suspension Fittings

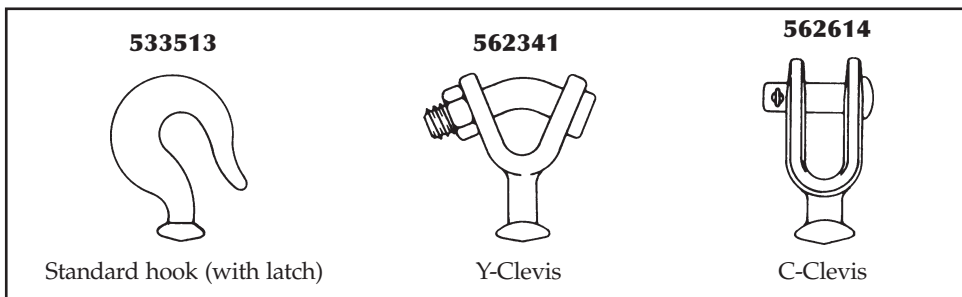

320 Libbey Industrial Parkway, Weymouth, Massachusetts 02189
Phone 781-331-5500 • Fax 781-331-5508 • www.hydroninc.com

HYDRON INCORPORATED

STRINGING BLOCKS



EASY RIDER™

The Jameson Easy Rider™ overlash block is an economical, high strength and lightweight overlash tool. It can be snapped over a strand and cable package up to 2-1/4" in diameter.

Features and Benefits

- High rounded top bonnet prevents block from kicking under lasher. Stacks evenly.
- Brass roller axle allows the rollers to "ride easily" and rotate smoothly
- High strength steel frame maintains better cable alignment
- 1-1/2" width provides easy stacking when pushed by lasher
- Available with nylon or aluminum rollers

No.	Description
90-400	Easy Rider with nylon roller
90-400A	Easy Rider block with aluminum roller



Versa™ Block 90-100A



Versa™ Block 90-100

VERSA™ BLOCK

The Versa™ Block offers the versatility of stringing cable at midspan on both new and existing overlash construction. It is ideally suited for easy cable placement from aerial lift buckets, as well as from ground positions, using lay-up sticks.

Features and Benefits

- Can be used on new or overlash construction
- Installs easily with lay-up sticks and a wire raising tool
- Low profile shaped frame greatly reduces cable damage as it passes through the block
- Wide keeper arm opening accommodates up to 3" cable bundles
- Available with rubber or aluminum rollers

No.	Description
90-100	Versa Block with rubber roller
90-100A	Versa Block with aluminum roller



Easy Rider™ 900-400A



Easy Rider™ 90-400

CORNER BLOCKS

Jameson corner blocks come in 60° and 90° styles, designed to evenly distribute the pressure on the cable when pulling around corners. The 60° model offers more versatility than a standard 45° block with the majority of system designs. The steel side plates can be replaced in the field, offering considerable savings and increased options. All Jameson corner blocks are interchangeable with competitive set-up brackets.

Features and Benefits

- Parts for the Jameson 60° and 90° blocks are interchangeable
- Steel side plates are designed with a straight base which acts as a strut, for increased strength
- All parts are field replaceable

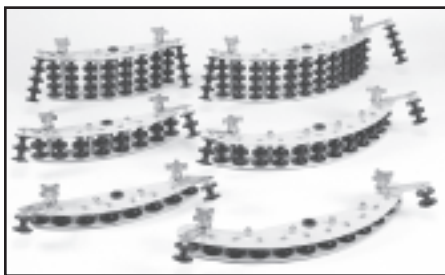

No.	Description
60° Corner Block with Nylon Rollers	
80-161	Corner Block - single
80-162	Corner Block - dual
80-164	Corner Block - quad
60° Corner Block with 1 Row Aluminum Rollers	
80-161A	Corner Block - single
80-162A	Corner Block - dual
80-164A	Corner Block - quad

No.	Description
90° Corner Block with Nylon Rollers	
80-591	Corner Block - single
80-592	Corner Block - dual
80-594	Corner Block - quad
90° Corner Block with 1 Row Aluminum Rollers	
80-591A	Corner Block - single
80-592A	Corner Block - dual
80-594A	Corner Block - quad

POLE MOUNT/SET-UP BRACKETS

No.	Description
70-101	Single Pole Mount Bracket
70-102	Double Pole Mount Bracket
70-104	Quad (Universal) Pole Mount Bracket
70-301	Single Set-Up Bracket
70-302	Double Set-Up Bracket
70-303	Quad Set-Up Bracket

LINE
CONSTRUCTION
TOOLS

320 Libbey Industrial Parkway, Weymouth, Massachusetts 02189
Phone 781-331-5500 • Fax 781-331-5508 • www.hydrone.com